

Fronius®, Kemppi®, Panasonic® Contact Tips

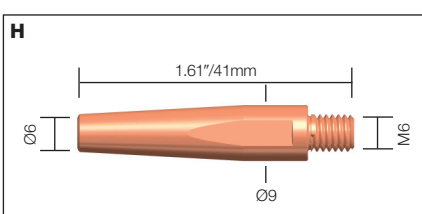
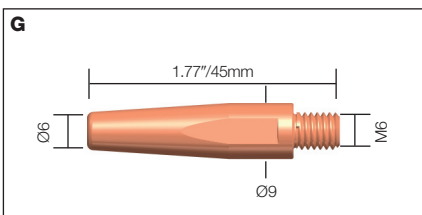
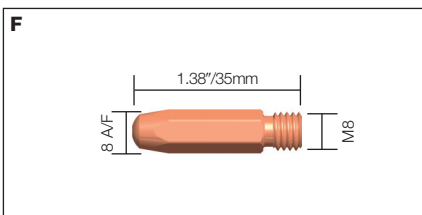
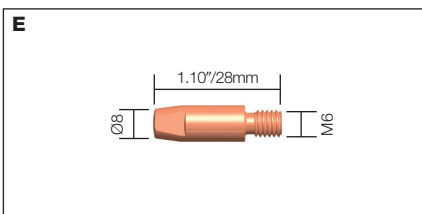
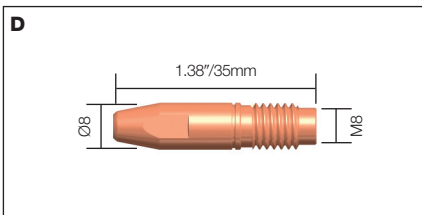
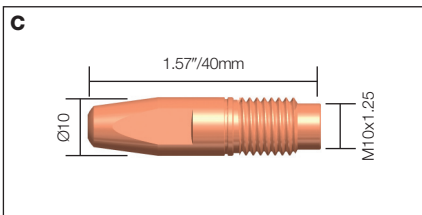
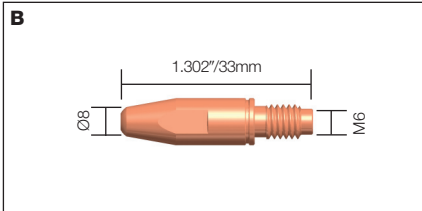
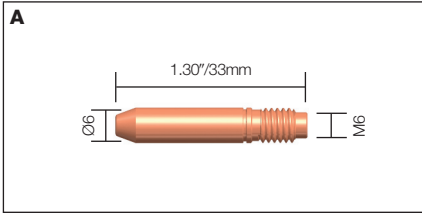

Fronius® Contact Tips

Stock Code	Description	Wire Size	Wire Size	Material	Model
A 42.0001.0052	Contact Tip M6	.023"	0.6mm	Ecu	AL225, 2300, 2500, 262, 3000, 4000, AW225, 352

Stock Code	Description	Wire Size	Wire Size	Material	Model
B 42.0001.0053	Contact Tip M6	.030"	0.8mm	Ecu	AL225, 2300, 2500, 262, 3000, 4000, AW225, 352
42.0001.0054	Contact Tip M6	.040"	1.0mm	Ecu	AL225, 2300, 2500, 262, 3000, 4000, AW225, 352
42.0001.0055	Contact Tip M6	.045"	1.2mm	Ecu	AL225, 2300, 2500, 262, 3000, 4000, AW225, 352

Stock Code	Description	Wire Size	Wire Size	Material	Model
C 42.0001.1576	Contact Tip M10	.030"	0.8mm	CuCrZr	AL372, 4000, 5000, AW502
42.0001.1577	Contact Tip M10	.040"	1.0mm	CuCrZr	AL372, 4000, 5000, AW502
42.0001.1578	Contact Tip M10	.045"	1.2mm	CuCrZr	AL372, 4000, 5000, AW502
42.0001.1930	Contact Tip M10	.055"	1.4mm	CuCrZr	AL372, 4000, 5000, AW502
42.0001.1579	Contact Tip M10	1/16"	1.6mm	CuCrZr	AL372, 4000, 5000, AW502

Stock Code	Description	Wire Size	Wire Size	Material	Model
D 42.0001.2911	Contact Tip M8	.030"	0.8mm	CuCrZr	AL3000, 4000
42.0001.2912	Contact Tip M8	.040"	1.0mm	CuCrZr	AL3000, 4000
42.0001.2913	Contact Tip M8	.045"	1.2mm	CuCrZr	AL3000, 4000

Kemppi® Contact Tips

Stock Code	Description	Wire Size	Wire Size	Material	Model
E 9876634	Contact Tip M6	.023"	0.6mm	Ecu	MT/PMT25/135
9876635	Contact Tip M6	.030"	0.8mm	Ecu	MT/PMT25/135
9876636	Contact Tip M6	.040"	1.0mm	Ecu	MT/PMT25/135
9876637	Contact Tip M6	.045"	1.2mm	Ecu	MT/PMT25/135

Stock Code	Description	Wire Size	Wire Size	Material	Model
F 9580122	Contact Tip M6	.030"	0.8mm	Ecu	PMT27, 30, 30W, 32, 42W, 50, 52W
9580123	Contact Tip M6	.040"	1.0mm	Ecu	PMT27, 30, 30W, 32, 42W, 50, 52W
9580124	Contact Tip M6	.045"	1.2mm	Ecu	PMT27, 30, 30W, 32, 42W, 50, 52W
9580125	Contact Tip M6	.055"	1.4mm	Ecu	PMT27, 30, 30W, 32, 42W, 50, 52W
9580126	Contact Tip M6	1/16"	1.6mm	Ecu	PMT27, 30, 30W, 32, 42W, 50, 52W

Panasonic® Contact Tips

Stock Code	Description	Wire Size	Wire Size	Material	Model
G J41/0.8	Contact Tip	.030"	0.8mm	Ecu	
J41/1.0	Contact Tip	.040"	1.0mm	Ecu	
J41/1.2	Contact Tip	.045"	1.2mm	Ecu	

Stock Code	Description	Wire Size	Wire Size	Material	Model
H J45/0.8	Contact Tip	.030"	0.8mm	Ecu	
J45/1.0	Contact Tip	.040"	1.0mm	Ecu	
J45/1.2	Contact Tip	.045"	1.2mm	Ecu	

Wire Guide Tubes

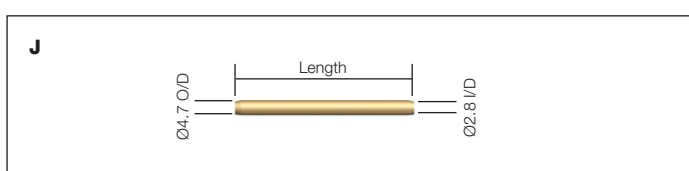
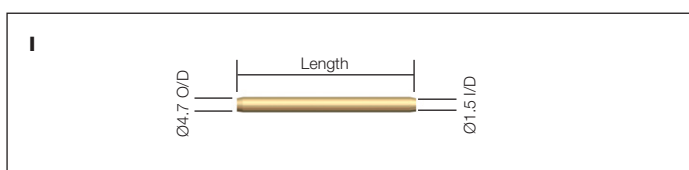
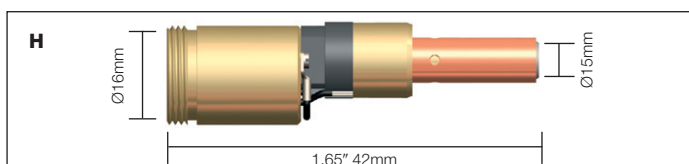
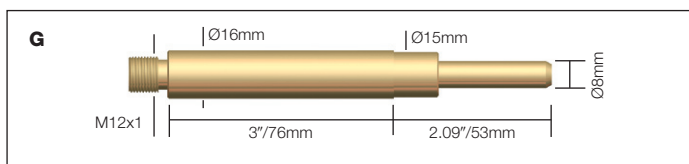
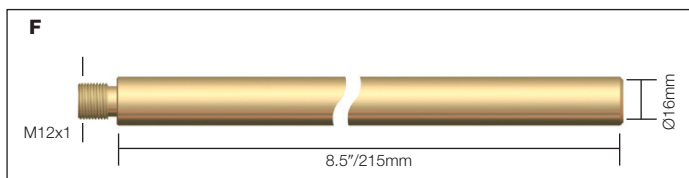
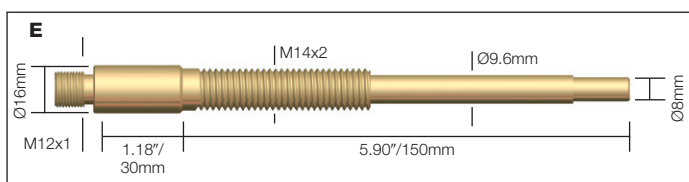
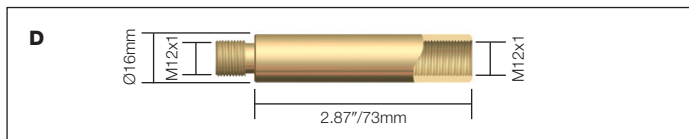
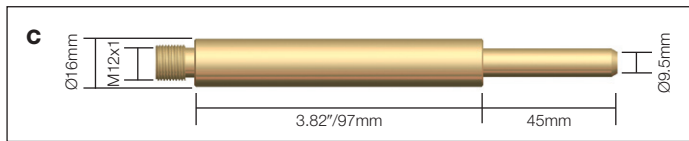
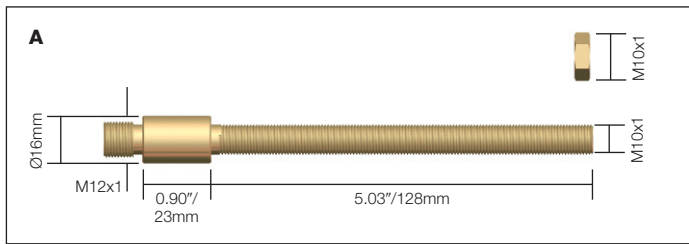

Wire Guide Tubes

Stock Code Description

A	B7030	Universal Guide Tube
	B1505	Locknut to Suit
NI	B1007	Complete Conversion Kit including Wire Guide Tube, Euroblock, Plastic Flange and Current Clamp

Stock Code Description

B	B7031	Migatronik Wire Guide Tube
NI	B1011	Complete Conversion Kit including Wire Guide Tube, Euroblock, Plastic Flange and Current Clamp

Stock Code Description

C	B7041	Maxac 300 Wire Guide Tube
NI	B1004	Complete Conversion Kit including Wire Guide Tube, Euroblock, Plastic Flange and Current Clamp

Stock Code Description

D	B7043	MK1 2 Roll Wire Guide Tube
NI	B1005	Complete Conversion Kit including Wire Guide Tube, Euroblock, Plastic Flange and Current Clamp

Stock Code Description

E	B7044	Lincoln 2000F Wire Guide Tube
NI	B1066	Complete Conversion Kit including Wire Guide Tube, Euroblock, Plastic Flange and Current Clamp

Stock Code Description

F	B7048	Standard Wire Guide Tube
NI	B1015	Complete Conversion Kit including Wire Guide Tube, Euroblock, Plastic Flange and Current Clamp

Stock Code Description

G	B7062	Kemppi Lisa 15 Wire Guide Tube
NI	B1017	Complete Conversion Kit including Wire Guide Tube, Euroblock, Plastic Flange and Current Clamp

Stock Code Description

H	B7067	Esab Connection Block
NI	B1015	Complete Conversion Kit including, Wire Guide Tube and Plastic Flange

Inlet Guides

Stock Code Description Size Size Length Length

I	B7090	Inlet Guide	.030"-0.45"	0.8/1.2mm	3.80"	96mm
	B7091	Inlet Guide	.030"-0.45"	0.8/1.2mm	4.72"	120mm
	B7092	Inlet Guide	.030"-0.45"	0.8/1.2mm	5.90"	150mm
	B7093	Inlet Guide	.030"-0.45"	0.8/1.2mm	7.09"	180mm
	B7094	Inlet Guide	.030"-0.45"	0.8/1.2mm	9.45"	240mm
	B7095	Inlet Guide	.030"-0.45"	0.8/1.2mm	11.80"	300mm

J	B7096	Inlet Guide	1/16"-3.32"	1.6/2.4mm	5.90"	150mm
	B7097	Inlet Guide	1/16"-3.32"	1.6/2.4mm	11.80"	300mm

Machine Conversion Kits

Special guide tubes can be manufactured to your specification. For a quotation please contact the sales office with the information detailed in A to E.

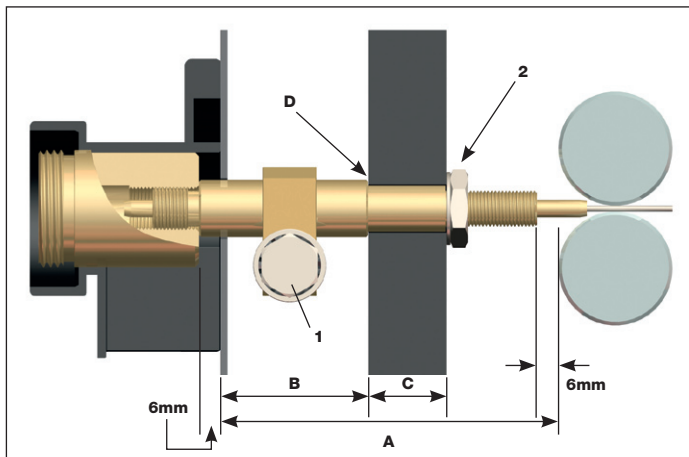

Required Information

- A** Distance from Face Plate to Drive Rolls
- B** Distance from Face Plate to Gear Box
- C** Gearbox Width
- D** Diameter of Hole in Gearbox
- E** Method of Power Current Pick Up (i.e. Current Clamp (1) or Locknut (2))

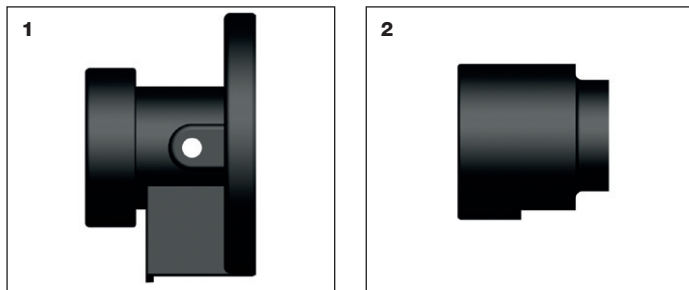

Components

Stock Code	Description
1 B7002	Plastic Flange
2 B7002R	Plastic Flange 2"/50mm



Stock Code	Description
3 B7002S	Square Plastic Flange

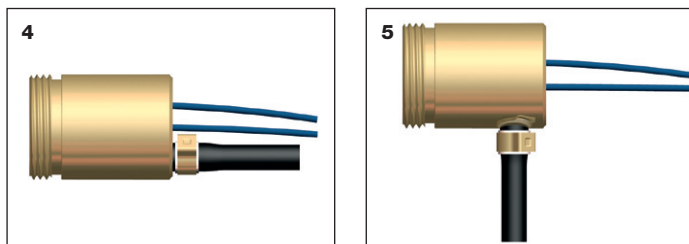

Stock Code	Description
4 B7001	Standard Connection Block
5 B7001S	Side Entry Connection Block

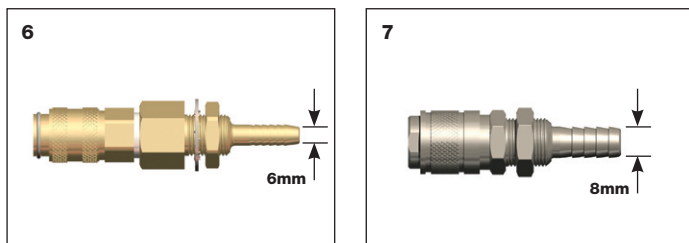

Stock Code	Description
6 B5034	Snap on Water Connector Small
7 801223	Snap on Water Connector Large

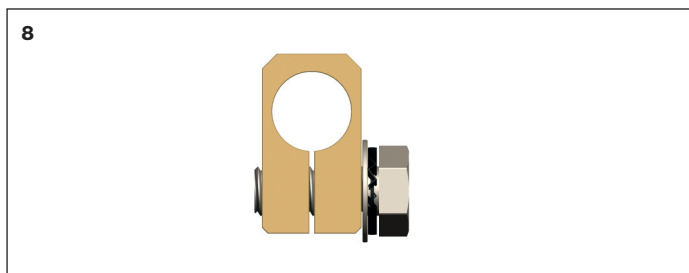

Stock Code	Description
8 B7017	Current Clamp

Hose/Sheath/Coaxial Cable

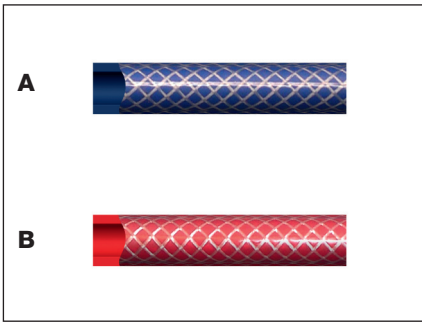

Reinforced PVC Hose				
Stock Code	Description	Bore	O/D	
A B5012B	Reinforced PVC Hose Blue	3/16"/5.0mm	5/16"/8.0mm	
B B5012R	Reinforced PVC Hose Red	3/16"/5.0mm	5/16"/8.0mm	

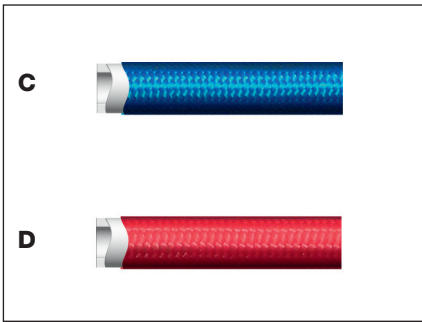

Overbraided Hose				
Stock Code	Description	Bore	O/D	
C B5012OBB	Rubber Overbraided Hose Blue	3/16"/5.0mm	.33"/8.5mm	
D B5012OBR	Rubber Overbraided Hose Red	3/16"/5.0mm	.33"/8.5mm	

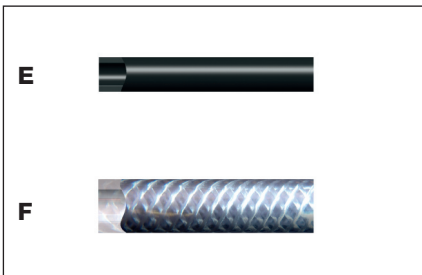

Hose Material				
Stock Code	Description	Bore	O/D	
E 4X1.2MM	Black Reinforced PVC Hose	5/32"/4.0mm	.25"/6.4mm	
5X1.2MM	Black Reinforced PVC Hose	3/16"/5.0mm	.30"/7.4mm	
F 7606-A	Argon Nylon Braided Hose	1/4"/6.0mm	3/8"/10.0mm	
7610-A	Argon Nylon Braided Hose	3/8"/10.0mm	1/2"/13.0mm	

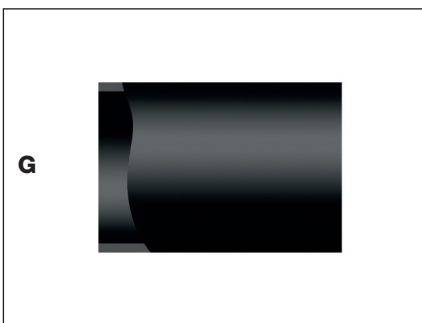

Canvas Cover				
Stock Code	Description	Bore	Wall Thickness	
G B5019/P	Rubberised Canvas Cover Plain	.98"/25mm	.06"/1.5mm	
B6019	Rubberised Canvas Cover Plain	1.10"/28mm	.06"/1.5mm	

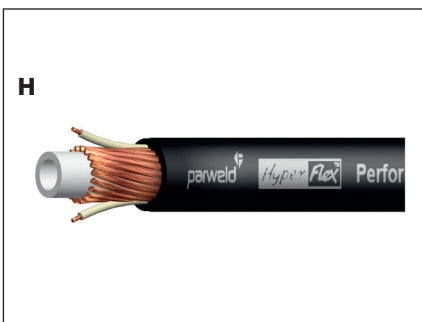

Coaxial Cable					
Stock Code	Description	Control Leads	Core Tube I/D	Core Tube Mat	
H HX 16MM	16mm ² Coaxial Cable	2	1/4"/6mm	Rubber	
HX 25MM	25mm ² Coaxial Cable	2	1/4"/6mm	Rubber	
HX 35MM	35mm ² Coaxial Cable	2	1/4"/6mm	Rubber	
HX 42MM	42mm ² Coaxial Cable	4	1/4"/6mm	Nylon	
HX 50MM	50mm ² Coaxial Cable	2	1/4"/6mm	Rubber	
HX 52MM	52mm ² Coaxial Cable	4	5/16"/8mm	Nylon	
HX 70MM	70mm ² Coaxial Cable	4	.35"/9mm	Nylon	

Liner Material/Welding Cable



Polyamide Liner Material				
Stock Code	Description	Bore	O/D	Wire Size
A B1564P	Polyamide Liner Material	5/64"/2.0mm	5/32"/4.0mm	.030"- .045"/0.8-1.2mm
B2564P	Polyamide Liner Material	.09"/2.3mm	.19"/4.7mm	.045"-1/16"/1.2-1.6mm
B3564P	Polyamide Liner Material	.11"/2.9mm	.19"/4.7mm	1/16"-5/64"/1.6-2.0mm

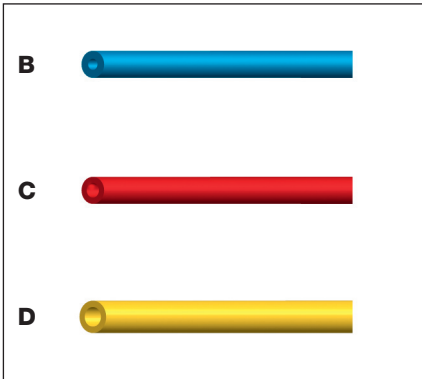

Teflon Liner Material				
Stock Code	Description	Bore	O/D	Wire Size
B B1536B	Teflon Liner Material	.06"/1.5mm	5/32"/4.0mm	.023"- .035"/0.6-0.9mm
C B2513	Teflon Liner Material	5/64"/2.1mm	.15"/3.9mm	.040"- .045"/1.0-1.2mm
D B3626	Teflon Liner Material	.11"/2.8mm	.18"/4.6mm	.045"-1/16"/1.2-1.6mm

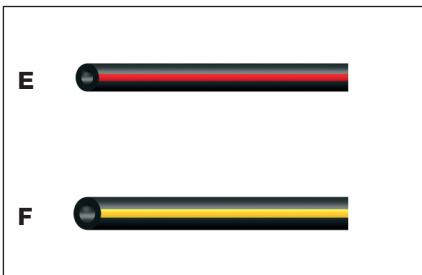

Carbon Teflon Liner Material				
Stock Code	Description	Bore	O/D	Wire Size
E B2554	Carbon Teflon Liner Material	5/64"/2.0mm	5/32"/4.0mm	.040"- .045"/1.0-1.2mm
F B3554	Carbon Teflon Liner Material	.10"/2.7mm	.19"/4.7mm	.045"-1/16"/1.2-1.6mm

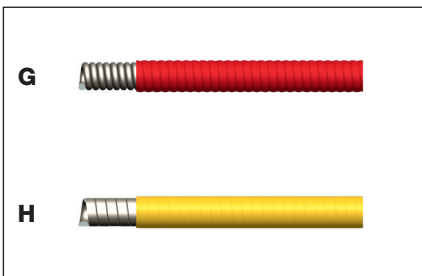

PVC Coated Steel Liner Material				
Stock Code	Description	Bore	O/D	Wire Size
G B2524PC	PVC Coated Liner Material	5/64"/2.0mm	.18"/4.5mm	.040"- .045"/1.0-1.2mm
H B3631PC	PVC Coated Liner Material	.10"/2.5mm	.18"/4.5mm	1/16"/1.6mm

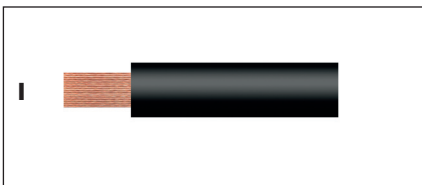

Welding Cable		
Stock Code	Description	Size
I 25MM CC	Single Insulated PVC Welding Cable	25mm ²
35MM CC	Single Insulated PVC Welding Cable	35mm ²
50MM CC	Single Insulated PVC Welding Cable	50mm ²